

TOSHIBA

INSTRUCTION MANUAL

CCD COLOR CAMERA

IK-64DNA

Please read this manual thoroughly before use, and keep it handy for future reference.

Record in space provided below the Model No. and the Seral No. as found on the label on the bottom of this unit.

Model. No. IK-64DNA Serial No. _____

Retain this information for future reference.

TABLE OF CONTENTS

Important Safeguards

1. Features & Descriptions	2
2. Cautions	2
3. Components	5
4. Part Name & Functions	6
5. Connections and Operations	8
6. Line-Lock Phase	8
7. Menu-Driven set-up	8
8. Remote Control	17
9. Note on Use and Installation	19
10. In Case of Problems	20
11. Specifications	21
12. Exterior View	22

IMPORTANT SAFEGUARDS

1. Read Instructions

All the safety and operating instructions should be read before the product is operated.

2. Retain Instructions

The safety instructions and instruction manual should be retained for future reference.

3. Heed Warnings

All warnings on the product and in the instruction manual should be adhered to.

4. Follow Instructions

All operating and use instructions should be followed.

5. Cleaning

Disconnect this video product from the power supply before cleaning.

6. Attachments

Do not use attachments not recommended by the video product manufacturer as they may cause hazards.

7. Water and Moisture

Do not use this video product near water-for example, near a bath tub, wash bowl, kitchen sink, or laundry tub, in a wet basement, or near a swimming pool and the like.

8. Accessories

Do not place this video product on an unstable cart, stand, tripod, bracket or table. The video product may fall, causing serious injury to a child or adult, and serious damage to the product. Use only with stand, tripod, bracket, or table recommended by the manufacturer, or sold with the video product. Any mounting of the product should follow the manufacturer's instructions, and should use a mounting accessory recommended by the manufacturer.

9. Ventilation

This video product should never be placed near or over a radiator or heat register. This video product should not be placed in a built-in installation such as a bookcase or rack unless proper ventilation is provided or the manufacturer's instructions have been adhered to.

10. Power Sources

This video product should be operated only from the type of power source indicated on the marking label. If you are not sure of the type of power supply to your location, consult your product dealer.

11. Power-Cord Protection

Power-Supply cords should be routed so that they are not likely to be walked on or pinched by items placed upon or against them, paying particular attention to cords at plugs, screws and the point where they exit from the product.

12. Lightning

For added protection for this video product during a lightning storm, or when it is left unattended and unused for long periods of time, unplug it from the wall outlet and disconnect the power supply and cable system. This will prevent damage to the video product due to lightning and power-line surges.

13. Overloading

Do not overload power supply and extension cords as this can result in a risk of fire or electric shock.

14. Object and Liquid Entry

Never push objects of any kind into this video product through openings as they may touch dangerous voltage points or short-out parts that could result in a fire or electrical shock. Never spill liquid of kind on the video product.

15. Servicing

Do not attempt to service this video product yourself as opening or removing covers may expose you to dangerous voltage or other hazards. Refer all servicing to qualified service personnel.

16. Damage Requiring service

Disconnect this video product from the power supply and refer servicing to qualified service personnel under the following conditions.

- when the power-supply cord or plug is damaged.
- If liquid has been spilled, or objects have fallen into the video product.
- If the video product has been exposed to rain or water.
- If the video product does not operate normally by following the operating instructions in the instruction manual. Adjust only those controls that are covered by the instruction manual as an improper adjustment of other controls may result in damage and will often require extensive work by a qualified technician to restore the video product to its normal operation.
- If the video product has been dropped or the cabinet has been damaged.
- When the video product exhibits a distinct change in performance-this indicates a need for service.

17. Replacement Parts

When replacement parts are required, be sure the service technician has used replacement parts specified by the manufacturer with the same characteristics as the original part. Unauthorized substitutions may result in fire, electric shock or other hazards.

18. Safety Check

Upon completion of any service or repairs to this video product, ask the service technician to perform safety checks to determine that the video product is in proper operating condition.



- The CAUTION label, shown on the left, is attached on the camera.



The lightning flash with arrowhead symbol, within an equilateral triangle, is intended to alert the user to the presence of uninsulated "dangerous voltage" within the product's enclosure that may be of sufficient magnitude to constitute a risk of electric shock to persons.



The exclamation point within an equilateral triangle is intended to alert the user to the presence of important operating and maintenance (servicing) instructions in the literature accompanying the appliance.

WARNING :
TO REDUCE THE RISK OF FIRE OR ELECTRIC SHOCK, DO NOT EXPOSE THIS APPLIANCE TO RAIN OR MOISTURE.

- **CAUTION**
CONNECT 24V AC UL LISTED CLASS 2 POWER SUPPLY.

FIELD INSTALLATION MARKING :
WORDED : "THIS INSTALLATION SHOULD BE MADE BY A QUALIFIED SERVICE PERSON AND SHOULD CONFORM TO ALL LOCAL CODES."

Note:The camera is indoor used

INFORMATION

This equipment has been tested and found to comply with the limits for a Class A digital device, pursuant to Part 15 of the FCC Rules. These limits are designed to provide reasonable protection against harmful interference when the equipment is operated in a commercial environment. This equipment generates, uses, and can radiate radio frequency energy and, if not installed and used in accordance with the instruction manual, may cause harmful interference to radio communications. Operation of this equipment in a residential area is likely to cause harmful interference in which case the user will be required to correct the interference at his own expense.

USER-INSTALLER CAUTION : Your authority to operate this FCC verified equipment could be voided if you make changes or modifications not expressly approved by the party

1. FEATURES & DESCRIPTION :

The IK-64DNA has the following features .

- (1) 0.003Lux@1.2 Minimum illumination in B/W mode
New IR-sensitive CCD and Auto-switching infrared cut filter function is provided
- (2) Intelligent 3 mode switching for Color to B/W
AUTO, RS422 remote control (TOSHIBA-P, TOSHIBA-D) and manual switching (B.C.G)
- (3) 570 horizontal TV lines in B/W mode
In B/W mode, Y-signal filter of CCD also cuts simultaneously
- (4) Menu-Driven programming
- (5) Remote control from a keyboard etc. by RS422.
- (6) Up to 1/100,000 sec shutter speed.
- (7) Easy install into any AC24V/DC12V system

2. Cautions :

- (1) In order to protect the camera, avoid placing or using it under direct sunlight, rain or dust.
- (2) Avoid touching the CCD sensor with your fingers. If necessary, use a soft cloth moistened with alcohol to wipe off any dust.
- (3) When the camera is not in use, keep the lens cap attached to protect the CCD sensor.
- (4) Avoid aiming the camera at the sun.
- (5) Avoid shooting the camera at intense light. Intense light such as a spotlight may cause a bloom or smear. A vertical stripe may appear on the screen. However, this is not a malfunction.
- (6) Install the camera away from video noise. If cables are wired near electric lighting wires or a TV set, noise may appear in images. In this event, relocate cables or reinstall equipment.

3. Components :

- (1) Camera 1
- (2) Accessories
 - (a) Lens Connector 1 (E4-191J-100(M))
 - (b) Instruction Manual 1
 - (c) Lens Cap 1
 - (d) Lens, coaxial cable and power cord are not supplied with the camera.

4. PART NAMES & FUNCTIONS :

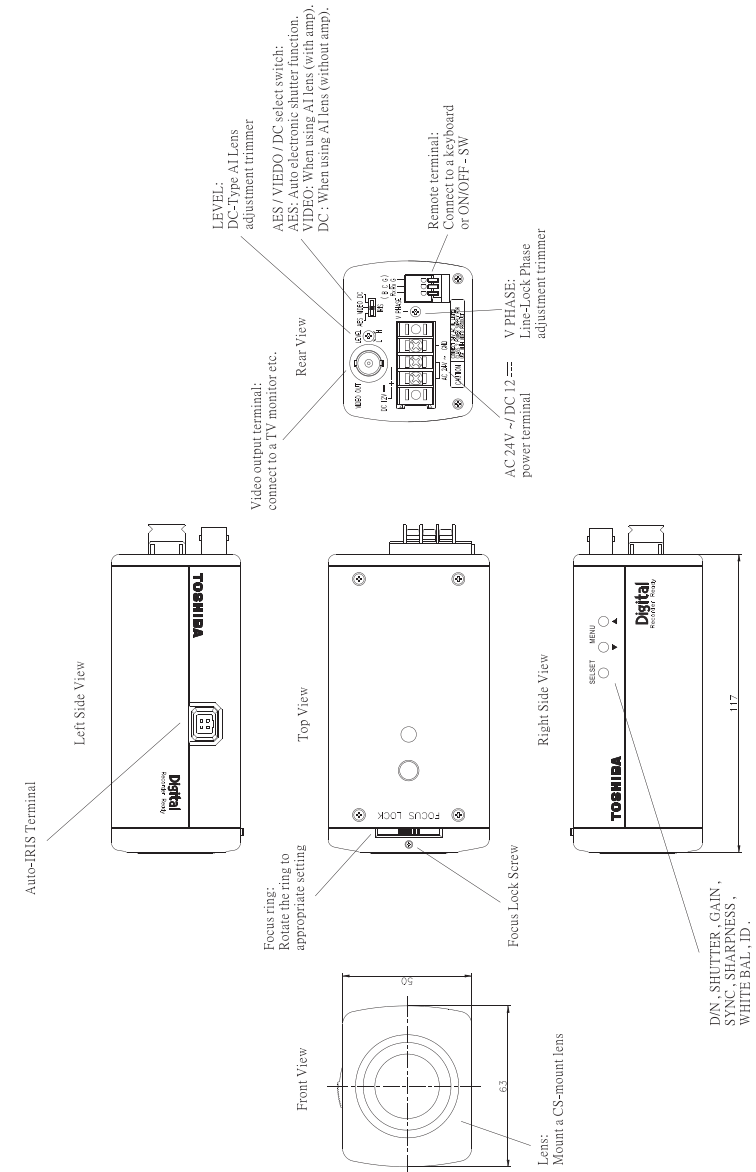

5. CONNECTIONS AND OPERATIONS :

Notes on connecting

- Power plugs of connected equipment must be disconnected before installations.
- A 75-ohm coaxial cable (3C-2V or 5C-2V) is required for standard connection.
- For details of wiring and operation of equipment to be connected, refer to their operation manuals.
- Lenses, coaxial cables for video signals and the power cord are not supplied with the camera.

Refer to the operations manuals of connected equipment for detailed wiring and overall operation instructions.

5-1 Basic connection since system configuration

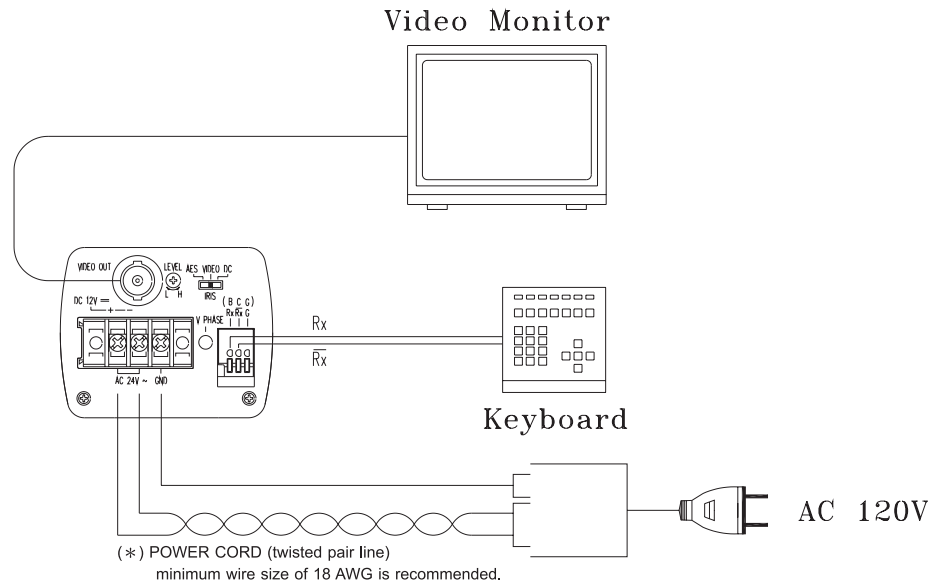

24V AC UL Listed Class 2 power supply / 12V DC power supply

CAUTION : Never input 24V AC and 12V DC at the same time

Do not overload power supply

Since this camera uses 24V AC UL Listed Class 2 power supply or 12V DC power supply, it should be connected to a power supply that allows for at least 15w consumption. Because the IK-64DNA uses a mechanism, a sufficient power supply with a dequate current specifications is required.

5-2 Line-Lock Control

- Matching the vertical synchronization with the power frequency is called the Line-Lock.
- This function is activated when the SYNC menu is selected to LL.
- When two or more cameras are switched by the video switcher for viewing by a monitor TV, the vertical sync. phase can be locked with the power frequency, and a stable vertical sync. is obtained without being disturbed at the time of switching.

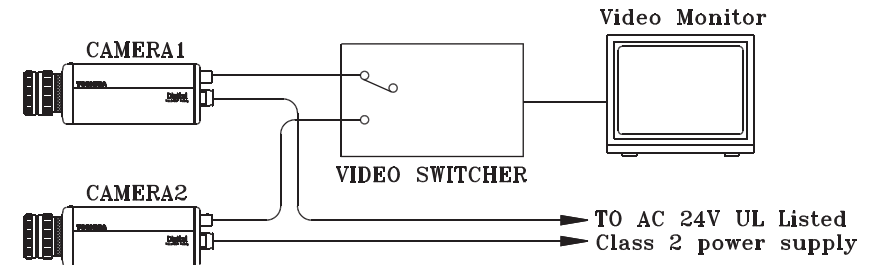

Note :

- The camera is synchronized to the power frequency of 60 ± 1 Hz covering a normal fluctuation of the power frequency. However, the camera may not cover a large fluctuation caused from the power generated by an engine generator, etc.
- It takes about 10 seconds or more until a stable synchronization is obtained after the power is turned on .This is normal, because several seconds are required to stabilize the camera against power noise.
- Refer to "6 LINE-LOCK PHASE" for adjustment.

5-3 Operation :

- (1) Before mounting a lens, check whether it is a "C" mount or "CS" mount type lens. If a "C" mount lens is used, an adapter ring is required and the back focus will need to be adjusted.
- (2) Mount the lens on the camera by turning the lens clockwise. Adjust the diaphragm and focus for optimum image.
- (3) Connect the VIDEO output to the video monitor. The picture will appear on the monitor screen as the power is supplied to the camera.
- (4) Adjust the focus and aperture of the lens for best image quality.

5-4 Back-Focus Adjustment

Back focus is adjusted at the factory to accommodate most standard lenses. If a slight adjustment is needed, mount the lens to the camera first. Then loosen the Focus Lock Screw. Rotate the Focus ring until a clear image is achieved. Retighten the Focus Lock Screw.

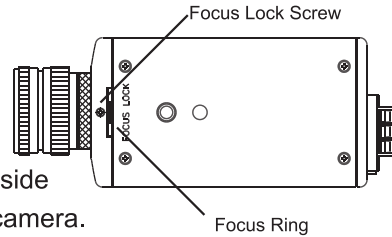

Note

When the lens weight is more than 1 kg (2.2 lbs), support the camera on the lens side rather than relying on the tripod mount of the camera.

5-5 Lens

This camera supports two types of auto-iris lens: Video-type and DC (direct drive) types. Connect the auto-iris connector plug to the IRIS terminal on the side of the camera. Refer to the chart below for correct wiring and set up.

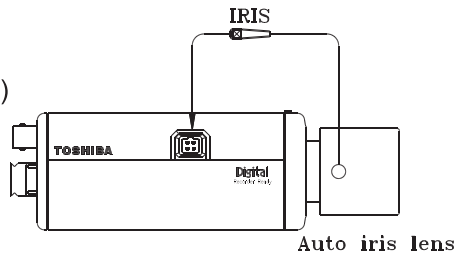

	Video IRIS Lens	Direct Drive IRIS Lens
IRIS terminal pin	1. + 12V	1. Damp-(y)
	2. NC	2. Damp+(γ)
	3. VIDEO	3. Driver+(wh)
	4. GND	4. Driver-(g)
IRIS Switch	VIDEO position	DC position

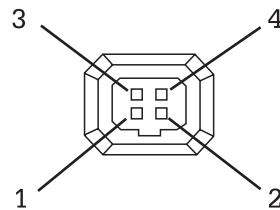

6. LINE LOCK PHASE

When a video switcher switches two or more cameras, the picture may fluctuate on the video monitor due to the different AC line phase of each camera. In this case, adjust the V PHASE controller (on rear panel) to get a stable image.

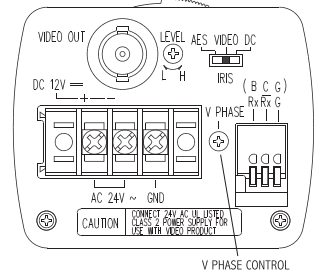

7. MENU DRIVEN SET-UP

The following is the on-screen menu structure for all settings and adjustments of the camera.

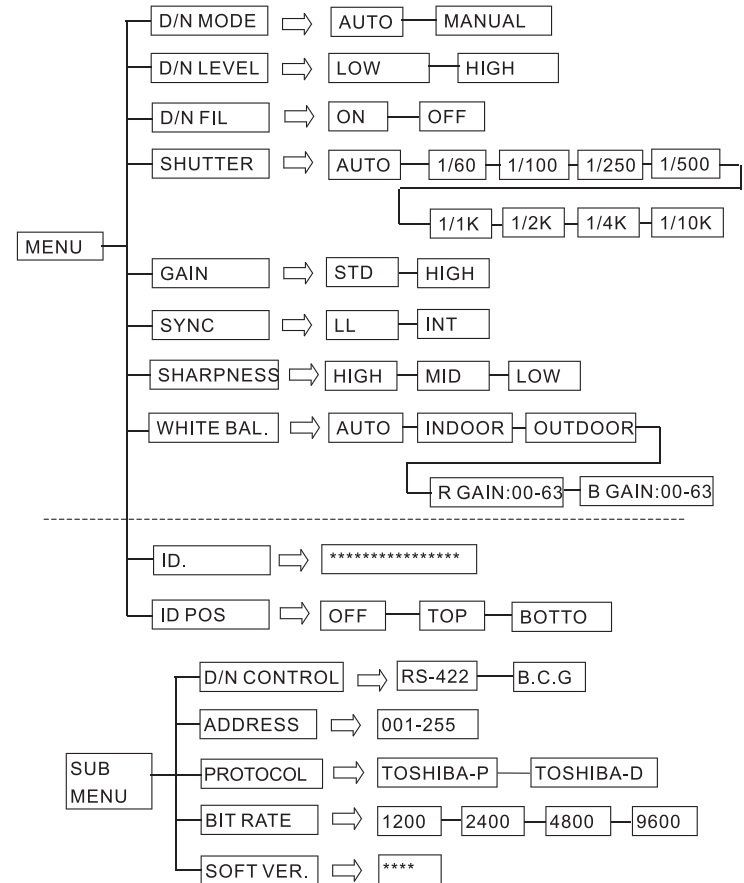

7-1. Setting switches and the functions

On the side panel of the cameras there are three push button switches as shown below:

Switch name	Main function
Select	Setting mode calls ON/OFF, setting entry
▼	Setting item selection (down)
▲	Setting item selection (up)

7-2 On screen MAIN menu

The camera is adjusted using the on screen menu. Press and hold the select switch on the side of the camera body 2 seconds until the menu appears on the monitor. The blinked area represents the option to be set.

7-2-1 D/N MODE

Set up a day/night function automatically or manually. Move the cursor to the position in Fig.

Use the SELECT switches to select AUTO, MANUAL

AUTO: When set to this mode, the camera will change to COLOR mode and B/W mode automatically according to a subject's brightness.

MANUAL: When set to this mode, the camera will change to COLOR mode and B/W mode manually according to a RS-422 commands or simple locking switches (B.C.G). (Refer to 7-3 On screen SUB menu)

D/N MODE	AUTO
D/N LEVEL	HIGH
D/N FIL	ON
SHUTTER	AUTO
GAIN	STD
SYNC	LL
BLC	OFF
SHARPNESS	HIGH
WHITE BAL.	AUTO
NEXT EXIT CANCEL DEFAULT	
ID.	*****
ID POS	OFF
BACK EXIT CANCEL DEFAULT	

7-2-2 D/N LEVEL

Set up a switchover point from B/W mode to COLOR mode

Move the cursor to the position in Fig.

Use the SELECT switches to select LOW, HIGH Under the AUTO mode, the switchover point of brightness from COLOR mode to B/W mode is 1.5 lx.

LOW : The switchover point of brightness from B/W mode to COLOR mode is 4.5 lx.

HIGH : The switchover point of brightness from B/W mode to COLOR mode is 7.5 lx.

(To switch between color mode and B/W mode within a short time, use this setup.)

D/N MODE	AUTO
D/N LEVEL	HIGH
D/N FIL	ON
SHUTTER	AUTO
GAIN	STD
SYNC	LL
BLC	OFF
SHARPNESS	HIGH
WHITE BAL.	AUTO
NEXT EXIT CANCEL DEFAULT	
ID.	*****
ID POS	OFF
BACK EXIT CANCEL DEFAULT	

7-2-3 D/N FIL = D/N FILTER

Set up a filter of CCD output in B/W mode

Move the cursor to the position in Fig.

Use the SELECT switches to select ON, OFF

ON: Y-signal filter of CCD output is narrow in B/W mode. In this position, the horizontal resolution is 480 TV lines.

OFF: Y-signal filter of CCD output is wide in B/W mode. In this position, the horizontal resolution is 570 TV lines. (If there is horizontal noise in B/W mode, set to ON.)

D/N MODE	AUTO
D/N LEVEL	HIGH
D/N FIL	ON
SHUTTER	AUTO
GAIN	STD
SYNC	LL
BLC	OFF
SHARPNESS	HIGH
WHITE BAL.	AUTO
NEXT EXIT CANCEL DEFAULT	
ID.	*****
ID POS	OFF
BACK EXIT CANCEL DEFAULT	

7-2-4 SHUTTER

Exposure time setting in AES (MES) position of IRIS switch on rear of the camera

Move the cursor to the position in Fig.

Use the SELECT switches to select AUTO, 1/60, 1/100, 1/250, 1/500, 1/1K, 1/2K, 1/4K, and 1/10K

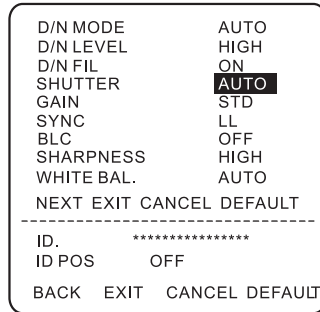

AUTO: Exposure time is controlled automatically within a range of 1/60 sec, to 1/100,000 sec to obtain an adequate signal.

1/60, 1/100, 1/250, 1/500, 1/1K, 1/2K, 1/4K, and 1/10K: Manual shutter (When an auto iris lens is used, it will display as IRIS.)

7-2-5 GAIN =AGC gain setting

Move the cursor to the position in Fig.

Use the SELECT switches to select STD, HIGH

STD: Standard position, max gain= 21dB
HIGH: High-Sensitivity position, max gain = 30dB

(If there is noise in low light conditions, set to STD.

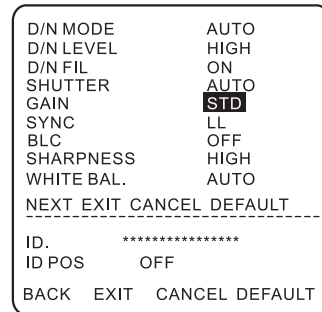

7-2-6 SYNC

Move the cursor to the position in Fig.

Use the SELECT switches to select INT, LL

INT: The camera is in the internal SYNC mode.

LL: The camera is in the Line-Lock mode. Line-Lock phase is set 0-300 degrees by adjusting the V-phase control at the rear of the camera.

(Refer to 5. Connections and Operations)

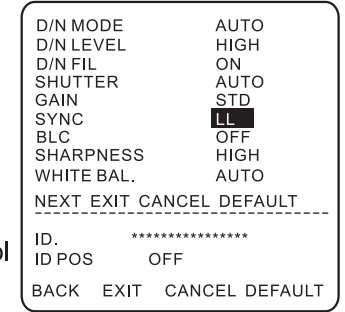

7-2-7 BLC =Back light compensation

Move the cursor to the position in Fig.

Use the SELECT switches to select OFF, BLC1, BLC2, BLC3, BLC4

Using in AES or auto iris lens, the exposure adjustment is automatically controlled so that the best picture is obtained at next monitor zone. This function is effective when strong light enters and auto iris lens closes.

OFF: The camera is not BLC mode.

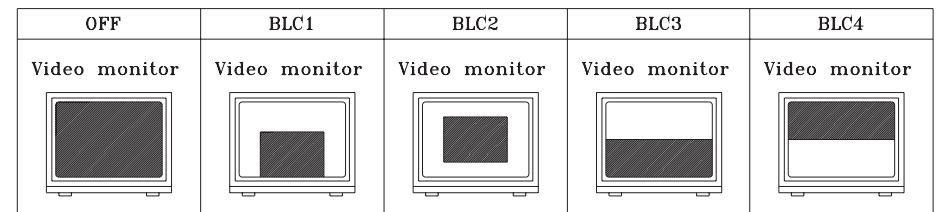
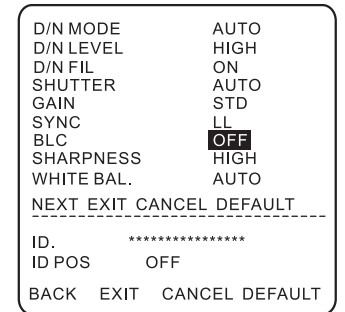

7-2-8 SHARPNESS

Move the cursor to the position in Fig.

Use the SELECT switches to select LOW, MID, HIGH

D/N MODE	AUTO
D/N LEVEL	HIGH
D/N FIL	ON
SHUTTER	AUTO
GAIN	STD
SYNC	LL
BLC	OFF
SHARPNESS	HIGH
WHITE BAL.	AUTO

NEXT	EXIT CANCEL DEFAULT

ID.	*****
ID POS	OFF

BACK	EXIT CANCEL DEFAULT

7-2-9 WHITE BAL =White balance

Move the cursor to the position in Fig.

Use the SELECT switches to select AUTO, INDOOR, OUTDOOR, R GAIN, and B GAIN

AUTO: The white balance is automatically adjusted according to the color temperature on the object. The camera is applicable to a color temperature range of 2500-10K.

INDOOR: The color temperature is fixed at 3200K.

OUTDOOR: The color temperature is fixed at 5100K.

R and B GAIN: Use the ▼▲ switches to adjust R Gain (Red) and B Gain (Blue) until the desired white balance is reached.

D/N MODE	AUTO
D/N LEVEL	HIGH
D/N FIL	ON
SHUTTER	AUTO
GAIN	STD
SYNC	LL
BLC	OFF
SHARPNESS	HIGH
WHITE BAL.	AUTO

NEXT	EXIT CANCEL DEFAULT

ID.	*****
ID POS	OFF

BACK	EXIT CANCEL DEFAULT

7-2-10 ID. =Camera ID.

Move the cursor to the position in Fig.

Use the SELECT switches to name each camera up to 16 characters.

(FONT LIST)

0,1,2,3,4,5,6,7,8,9

A,B,C,D,E,F,G,H,I,J,K,L,M,N,O,P,Q,R,

S,T,U,V,W,X,Y,Z:,<,>,-,.,,;,x,/_

D/N MODE	AUTO
D/N LEVEL	HIGH
D/N FIL	ON
SHUTTER	AUTO
GAIN	STD
SYNC	LL
BLC	OFF
SHARPNESS	HIGH
WHITE BAL.	AUTO

NEXT	EXIT CANCEL DEFAULT

ID.	*****
ID POS	OFF

BACK	EXIT CANCEL DEFAULT

7-2-11 ID POS =Camera ID. Position

Move the cursor to the position in Fig.

Use the SELECT switches to select OFF, TOP, and BOTTOM. Show the Camera ID in monitor screen.

OFF: The camera ID is not displayed

TOP: The camera ID is displayed at the top-left of the monitor

BOTTOM: The camera ID is displayed at the bottom-left of the monitor

D/N MODE	AUTO
D/N LEVEL	HIGH
D/N FIL	ON
SHUTTER	AUTO
GAIN	STD
SYNC	LL
BLC	OFF
SHARPNESS	HIGH
WHITE BAL.	AUTO

NEXT	EXIT CANCEL DEFAULT

ID.	*****
ID POS	OFF

BACK	EXIT CANCEL DEFAULT

7-2-12 NEXT, BACK

Move the cursor to the position in Fig.

Press the SELECT switch to select the past page or next page.

D/N MODE	AUTO
D/N LEVEL	HIGH
D/N FIL	ON
SHUTTER	AUTO
GAIN	STD
SYNC	LL
BLC	OFF
SHARPNESS	HIGH
WHITE BAL.	AUTO

NEXT	EXIT CANCEL DEFAULT

ID.	*****
ID POS	OFF

BACK	EXIT CANCEL DEFAULT

7-2-13 CANCEL

Move the cursor to the position in Fig.

Press the SELECT switch to exit the menu without saving any changes.

D/N MODE	AUTO
D/N LEVEL	HIGH
D/N FIL	ON
SHUTTER	AUTO
GAIN	STD
SYNC	LL
BLC	OFF
SHARPNESS	HIGH
WHITE BAL.	AUTO

NEXT	EXIT CANCEL DEFAULT

ID.	*****
ID POS	OFF

BACK	EXIT CANCEL DEFAULT

7-2-14 EXIT

Move the cursor to the position in Fig.

Press the SELECT switch to save all changes and exit the menu.

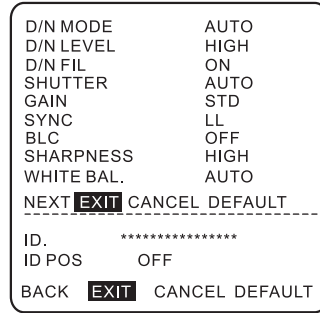

7-2-15 DEFAULT

Move the cursor to the position in Fig.

Press the SELECT switch to select DEFAULT, which returns the camera to its factory settings.

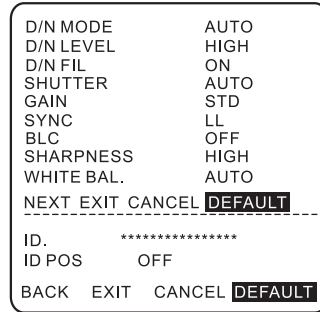

(Default settings)

D/N MODE AUTO
D/N LEVEL HIGH
D/N FIL ON
SHUTTER AUTO
GAIN STD
SYNC LL
BLC OFF
SHARPNESS HIGH
WHITE BAL. AUTO

ID.
ID. POS OFF

7-3 On screen SUB menu (FOR REMOTE CONTROL)

The camera is adjusted using a sub menu for setup using a remote control. Press and hold the ▲ switch on the side of the camera body 2 seconds until the menu appears on the monitor. The blinking area represents the option to be set.

(This sub menu cannot control from a keyboard by RS-422)

(Default settings)

D/N CONTROL RS-422
ADDRESS 001
PROTOCOL TOSHIBA-P
BIT RATE 4800

7-3-1 D/N CONTROL

Move the cursor to the position in Fig.

Use the SELECT switches to select RS-422, B.C.G

This setup changes Color mode and B/W mode manually.

It accepts when having set D/N MODE as MANUAL in the main menu.

RS-422: At this setup, D/N mode can be controlled by a remote control from a keyboard etc. by RS-422.

B.C.G: (B=B/W, C=Color, G=GND)

At this setup, a lock type switch is only connected with the terminal of rear of the camera and D/N mode can operate by switch settings.

Note: When using this setup, please be sure to change an internal switch. Refer to "8.Remote control" .

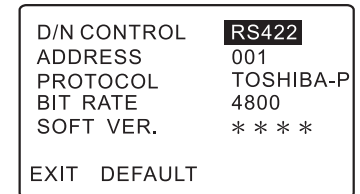

7-3-2 ADDRESS

Move the cursor to the position in Fig.

Use the SELECT ▲▼ switches to select 001 to 255

```

D/N CONTROL  RS422
ADDRESS      001
PROTOCOL     TOSHIBA-P
BIT RATE     4800
SOFT VER.    * * * *
EXIT  DEFAULT
    
```

7-3-3 Protocol

Move the cursor to the position in Fig.

Use the SELECT switches to select TOSHIBA-P, TOSHIBA-D

```

D/N CONTROL  RS422
ADDRESS      001
PROTOCOL     TOSHIBA-P
BIT RATE     4800
SOFT VER.    * * * *
EXIT  DEFAULT
    
```

7-3-4 BIT RATE

Move the cursor to the position in Fig.

Use the SELECT switches to select 1200, 2400, 4800, 9600bps

In RS-422 control, it is necessary to set a unique camera address I and bit rate for each camera.

```

D/N CONTROL  RS422
ADDRESS      001
PROTOCOL     TOSHIBA-P
BIT RATE     4800
SOFT VER.    * * * *
EXIT  DEFAULT
    
```

7-3-5 SOFT VER.

Software version display

8. Remote control :

This camera supports 2-type remote control.

8-1 RS-422 Control (Factory-setting) supported TOSHIBA-P and TOSHIBA-D

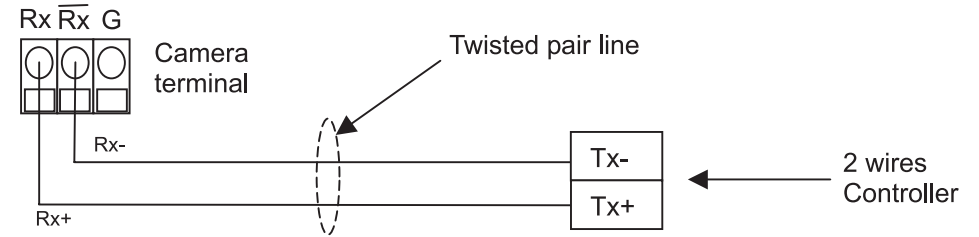

Tx of the communication line from KBD is connected to Rx of the camera, and Tx- is connected to Rx- of the camera.

Internal switch location

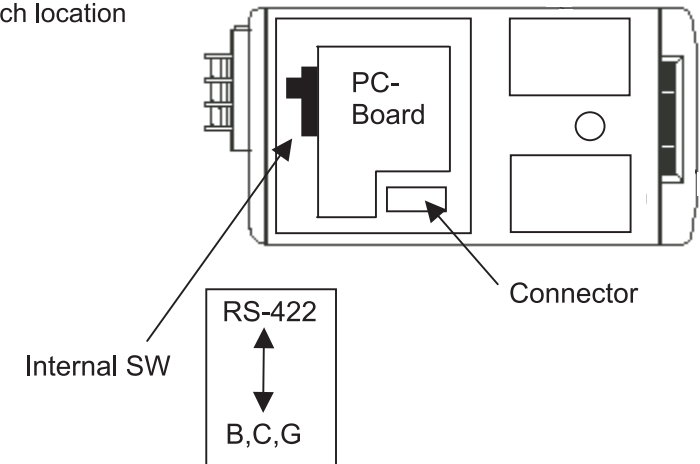

A controllable function is as follows.

Preset Number	Function
71 GO	Backlight compensation ON (zone: BLC2)
72 GO	Backlight compensation OFF
75 GO	Software version display
88 GO	IR cut filter ON (Color mode)
89 GO	IR cut filter OFF (B/W mode)
95 SET	Enter MENU mode

8-2 B.C.G Control

D/N control setup of a sub menu is set to B.C.G and an internal switch is set to the BCG side, the following remote control is possible about D/N mode.

Terminal B	Terminal C	MODE
OFF (H)	OFF (H)	AUTO
OFF (H)	ON (L)	COLOR
ON (L)	OFF (H)	B/W
ON (L)	ON (L)	B/W

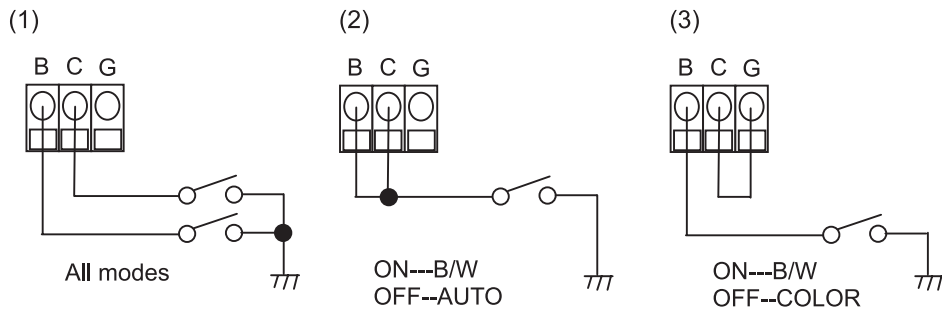

9. NOTE ON USE AND INSTALLATION

• Do not aim the camera at the sun

Do not aim the camera at the sun or point it at sun even if you are not shooting.

• Do not shoot intense light

Intense light such as a spotlight may cause a bloom or smear. A vertical stripe may appear on the screen. However, this is not a malfunction.

• Treat the camera with care

Do not drop the camera or subject it to strong shock of vibration. Otherwise, the camera may malfunction.

• Never touch internal parts

Do not touch the internal parts of the camera other than the parts specified. Otherwise, the camera may malfunction.

• Do not splash water on the camera

Install the camera where the camera can be kept dry. If the camera gets wet, turn off the power and contact your dealer.

• Check the ambient temperature and humidity

Avoid using the camera where the temperature is hotter or colder than specified. Otherwise, the quality of images may deteriorate or internal parts may be affected. Special care is required to use the camera at high temperature and humidity.

• Should you notice any trouble

If any trouble occurs while you are using the camera, turn off the power and contact your dealer. If you continue to use the camera when there is something wrong with it, the trouble may much worse and an unpredictable accident may occur.

10. IN CASE OF PROBLEMS

Condition	Check Points
No image	<ul style="list-style-type: none"> • Are the camera and connected equipment turned on? • Is the iris of the lens adjusted properly? • Are cables connected correctly?
Unnatural color	<ul style="list-style-type: none"> • Is the monitor TV adjusted correctly? • Is the lighting too weak?
Unusual operation of D/N mode	<ul style="list-style-type: none"> • Is the output of a power supply proper?

Press default to return the camera to factory settings (7.2.15)

11. SPECIFICATIONS

Power	AC24V 10% 60(50) Hz / DC12V 10%
Power consumption	7.5W with AI lens
Image sensor	1/3 inch high sensitive CCD
Image pickup area	4.96mm(0.195inch) horizontal x 6.0mm(0.236inch) vertical
Effective picture elements	768 horizontal x 494 vertical
Scanning system	2:1 interface NTSC standard TV system
Scanning frequency	15.75kHz horizontal, 60Hz vertical
Synchronization	Line- Lock, Internal
Resolution (Color)	Horizontal 480 TV lines (TYP) Vertical 350 TV lines or more
Resolution (B/W)	Horizontal 570 TV lines (TYP) (D/N FIL- OFF) Vertical 350 TV lines or more
Minimum subject illumination (Color)	0.1 lx (F1.2, AGC HIGH, more than 10% of image output)
Minimum subject illumination (B/W)	0.003 lx (F1.2, AGC HIGH, more than 10% of image output)
S/N	50dB (AGC OFF, Weight ON)
Video output	VBS 1.0Vp-p / 75 ohms, Composite
White balance	AUTO (2500K to 10,000K), MANUAL
IRIS control	DC / VIDEO - Iris driver circuit built in
Auto Electric shutter	ON(1/60 to 1/100,000), OFF(1/60)
Gain control	Average AGC - STD(21dB), HIGH(30dB)
Backlight compensation	4 mode BLC function
Lens mount	CS mount
Ambient temperature	-10C to +50C (14F to 122F)
Ambient humidity	90% max
Weight	500g
External dimensions	63mm(W) x 50mm(H) x 117mm(D)
Safety standard	UL2044, CSA C22.2
Emission standard	FCC/A, DOC/A

12. EXTERIOR VIEW

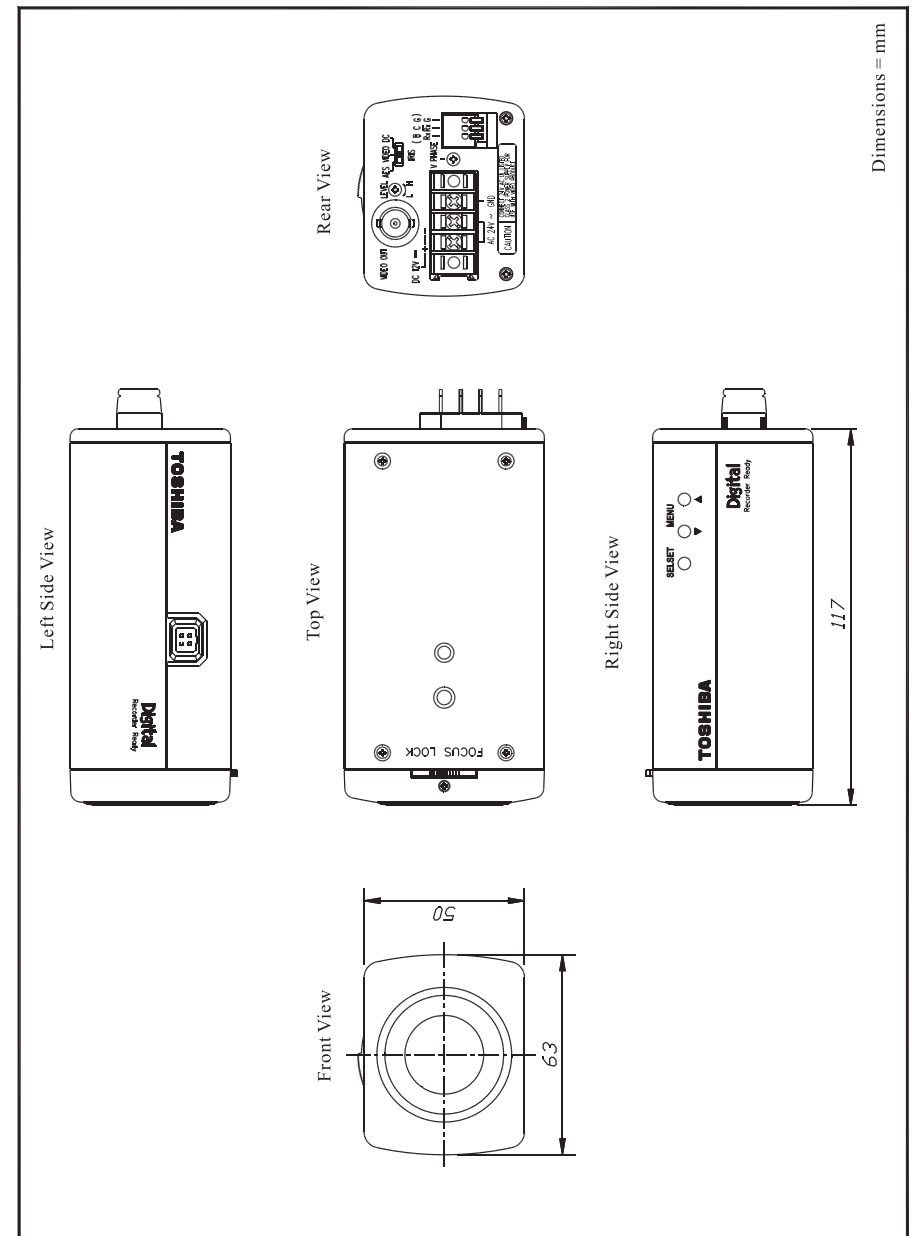

Camera Installation Guide

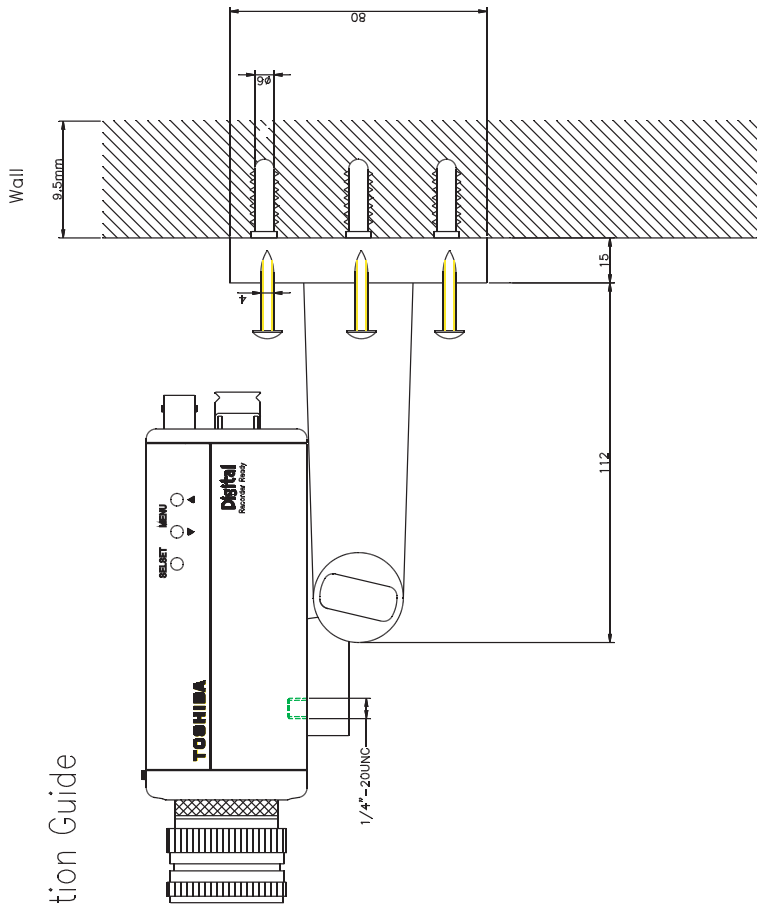

The Installation Guide is for reference only.
Bracket is not be enclosed.

EIM-0010325

4/26/2000

LIMITED WARRANTY CCD SECURITY CAMERA

The Imaging Systems Division of Toshiba America Information Systems, Inc. ("ISD") makes the following limited warranties with regard to this CCD Camera ("Product"). These limited warranties extend to the Original End-User ("You[r]").

One (3) Year Limited Warranty of Labor and Parts ISD warrants that this Product will perform in accordance with specifications for a period of one (3) year from the date of purchase by the Original End-User. During this one (3) year period, ISD will repair or replace the Product, if it does not perform as warranted. In order to take advantage of this Limited Warranty, You must: (a) deliver the Product to an ISD Authorized Service Provider ("ASP"); and (b) pay all transportation and insurance charges for shipment of the Product to the ASP. ISD reserves the right to substitute factory refurbished parts in place of those in need of repair.

Instruction Manual (Owner's Manual): You should read the Instruction Manual (Owner's Manual) thoroughly before operating this Product. Before seeking warranty service, you should check the troubleshooting guide in the Instruction Manual (Owner's Manual) and follow the instructions to correct the problem.

How to Obtain Warranty Service Step-by-step Procedures: To obtain warranty service, You should:

1. Contact Toshiba at (877) 855-1349 for operation or installation assistance. (877) 855-1FX
2. Contact an ASP for warranty service within thirty (30) days after the Product fails to comply with specifications.
3. Arrange for shipment of the Product to a Toshiba Authorized Service Provider.
4. Securely pack the Product in the original carton and external shipping pack, include a letter explaining the problem with a copy of the bill of sale or proof of purchase.
5. Prepay all transportation and insurance costs.

Questions? If you have any questions, please check our web site at <http://www.toshiba.com/taisisd/security/>

Your Responsibilities: This Limited Warranty is subject to the following conditions:

1. You must provide the bill of sale or proof of purchase at the time that warranty service is required.
2. You must notify an ASP within thirty (30) days after you discover that the product does not perform in accordance with specifications during the Limited Warranty period.
3. All Warranty Service of this product must be by an ISD Authorized Service Provider.
4. You must pack the Product in its original carton using the original packing material, then insert the original carton containing the Product into another carton with additional packing material before shipping the Product to an ASP.

DISCLAIMERS:

ALL OTHER EXPRESS OR IMPLIED WARRANTIES ON THIS PRODUCT, INCLUDING THE IMPLIED WARRANTIES OF MERCHANTABILITY AND FITNESS FOR A PARTICULAR PURPOSE, ARE HEREBY DISCLAIMED. SOME STATES DO NOT ALLOW THE EXCLUSION OF IMPLIED WARRANTIES OR LIMITATIONS ON HOW LONG AN IMPLIED WARRANTY LASTS. SO THE ABOVE LIMITATIONS MAY NOT APPLY TO YOU.

IF THIS PRODUCT IS NOT IN GOOD WORKING ORDER AS WARRANTED ABOVE, YOUR SOLE AND EXCLUSIVE REMEDY SHALL BE THE REPAIR OR REPLACEMENT OF THE PRODUCT. IN NO EVENT WILL ISD OR ITS PARENT COMPANY OR ANY ASP BE LIABLE TO YOU OR ANY THIRD PARTY FOR ANY DAMAGES IN EXCESS OF THE PURCHASE PRICE OF THE PRODUCT. THIS LIMITATION APPLIES TO DAMAGES OF ANY KIND, INCLUDING ANY DIRECT OR INDIRECT DAMAGES, LOST PROFITS, LOST SAVINGS OR OTHER SPECIAL, INCIDENTAL, EXEMPLARY OR CONSEQUENTIAL DAMAGES, WHETHER FOR BREACH OF CONTRACT, TORT OR OTHERWISE, OR WHETHER ARISING OUT OF THE USE OF OR INABILITY TO USE SUCH PRODUCT, EVEN IF TAIS, ITS PARENT COMPANY, OR AN ASP HAS BEEN ADVISED OF THE POSSIBILITY OF SUCH DAMAGES OR OF ANY CLAIM BY ANY OTHER PARTY. SOME STATES DO NOT ALLOW THE EXCLUSION OR LIMITATION OF INCIDENTAL OR CONSEQUENTIAL DAMAGES FOR SOME PRODUCTS, SO THE ABOVE LIMITATIONS OR EXCLUSIONS MAY NOT APPLY TO YOU.

THIS WARRANTY GIVES YOU SPECIFIC LEGAL RIGHTS, AND YOU MAY ALSO HAVE OTHER RIGHTS WHICH MAY VARY FROM STATE TO STATE.

THIS LIMITED WARRANTY SHALL BE VOID IF THE PRODUCT OR PARTS HAVE BEEN SUBJECTED TO MISUSE, ABUSE, ACCIDENT, IMPROPER INSTALLATION, IMPROPER MAINTENANCE, OR USE IN VIOLATION OF ISD'S WRITTEN INSTRUCTIONS, OR WHERE THE PRODUCT HAS BEEN ALTERED OR MODIFIED WITHOUT ISD'S PRIOR AUTHORIZATION, OR UPON THE REMOVAL OR ALTERATION OF ISD'S FACTORY SERIAL NUMBER. LABOR SERVICE CHARGES FOR PRODUCT INSTALLATION, SET UP AND ADJUSTMENT OF CONTROLS ARE NOT COVERED BY THIS LIMITED WARRANTY.

No person, agent, distributor, dealer, authorized service provider, or company is authorized to change, modify, or extend the terms of this Limited Warranty in any manner whatsoever. The time within which an action must be commenced to enforce any obligation of ISD arising under this Limited Warranty or under any statute, or law of the United States or any state thereof, is hereby limited to one (3) year from the date You discovered should have discovered the problem. This limitation does not apply to implied warranties arising under state law. Some states do not permit limitation of the time within which You may bring an action beyond the limits provided by state law, so the above provision may not apply to You. This Limited Warranty gives You specific legal rights and You may also have other rights which vary from state to state.

TOSHIBA AMERICA INFORMATION SYSTEMS, INC.
Imaging Systems Division

TOSHIBA

MEMO
